



## Safety Instructions – CGR – Zone 0/1



**IECEX**

## Centurion Guided Radar HAWK CGR SERIES

### IECEX Zone 0/1

Intrinsically Safe probe / Flameproof enclosure

**IECEX TSA 14.0037X**

**Ex ia/d [ia Ga] IIC T6 Ga/Gb**

**Tamb = -40°C to +60°C**

**IP 66, NEMA 4X**

**(T6 ... T1)**

### Equipment types:

**CGR2 2 wire Centurion Guided Radar**

**CGR4 4 wire Centurion Guided Radar**

Document No: SI0050

Doc ID: 3548

Version 1.9

02 Feb 2016



## NOTES:

# Contents

<b>Centurion Guided Radar .....</b>	<b>1</b>
1. General.....	5
2. Hazardous Areas.....	5
3. Equipment Identification .....	6
4. Dual Compartment Enclosure .....	7
5. Putting Into Service .....	8
6. Conditions of Safe Use.....	9
7. Assembling and dismantling (Front & Rear covers only).....	10
8. Installation and Wiring .....	11
9. Adjustment .....	11
10. Enclosure (LCD) Orientation .....	12
11. Application Conditions.....	13
12. List of IECEx certified equipment types.....	14
13. Wiring configuration drawings .....	14
14. Approval Standards .....	14
15. IECEx Certificate of Conformity .....	14
16. Manufacturer Contact Information.....	15



Flexi cable

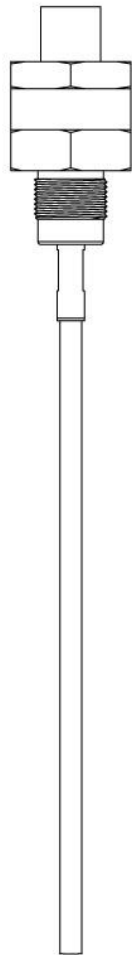

Rigid Probe

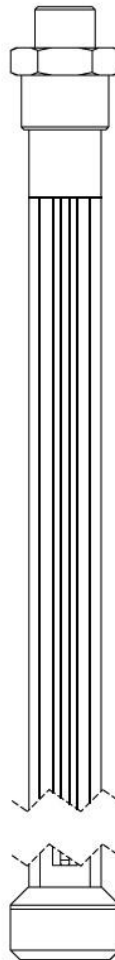

Coaxial Model 1



Coaxial Model 2

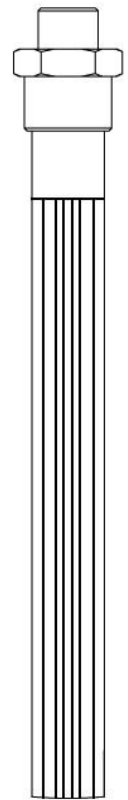

Coaxial Model 3

## 1. General

This document provides instructions for the safe installation of HAWK Centurion Guided Radar (CGR) series equipment, which is a process transmitter consisting of a sensing probe attached to an electronic control amplifier.

HAWK CGR series equipment is a continuous Level and Interface Measurement unit. It uses low power high frequency RF pulses based on the TDR principle to measure liquids and solids in contact with the sensing probe.

These units are usually mounted directly at the level measurement point – at the top of a storage vessel – with the probe directed downwards in contact with the material product surface. Refer to Installation Guide in the User Manual.

HAWK CGR units are available with either 2 wire loop power or 4 wire option. User interface controls shall be accessed only when an explosive atmosphere is not present.

## 2. Hazardous Areas

The HAWK CGR is certified under IECEx standards for installation in hazardous gas locations according to IECEx Certificate of Conformity IECEx TSA 14.0037A. IECEx certified equipment is recognised in most countries around the world.

The HAWK CGR enclosure has a dual compartment with segregated Ex d and cable connection sections. The amplifier is located inside the flameproof (Ex d) compartment and the user connections are terminated in the rear compartment, whereas the sensing probe is protected using the Intrinsic Safe (Ex ia) method, where the energy supplied from the amplifier is limited to a safe level according to the standards. Sensing Probe is mounted across the boundary of zone and acts as a sealing mechanism. Probe Seal comprises of SS316L, PEEK, PTFE+GF25 and O-rings (NBR, Viton, Kalrez, Silicone, etc).

Temperature class is T6 (85°C) which means that these units are also applicable in areas specified as T5 up to and including T1 (refer Section 5e). Ambient temperature ( $T_{amb}$ ) stated on the marking nameplate must be observed at all times.

When HAWK CGR equipment is installed and mounted in hazardous areas, these User Manual, Safety and Operating Instructions, the general Ex installation regulations and the general installation regulations for electrical equipment must all be observed.

Installation of Ex instruments should only be made by suitably trained personnel.

### Zone 0/1 areas

The CGR sensing probe can be installed into hazardous zones 0, 1 or 2, in gas groups IIC, IIB or IIA, whereas the amplifier enclosure can only be installed into zones 1 or 2.

### Zone 1 & Zone 2 areas

Both sensing probe and amplifier enclosure can be installed into hazardous zones 1 or 2, in gas groups IIC, IIB or IIA.

### 3. Equipment Identification

An image of the IECEx marking nameplate is shown below.

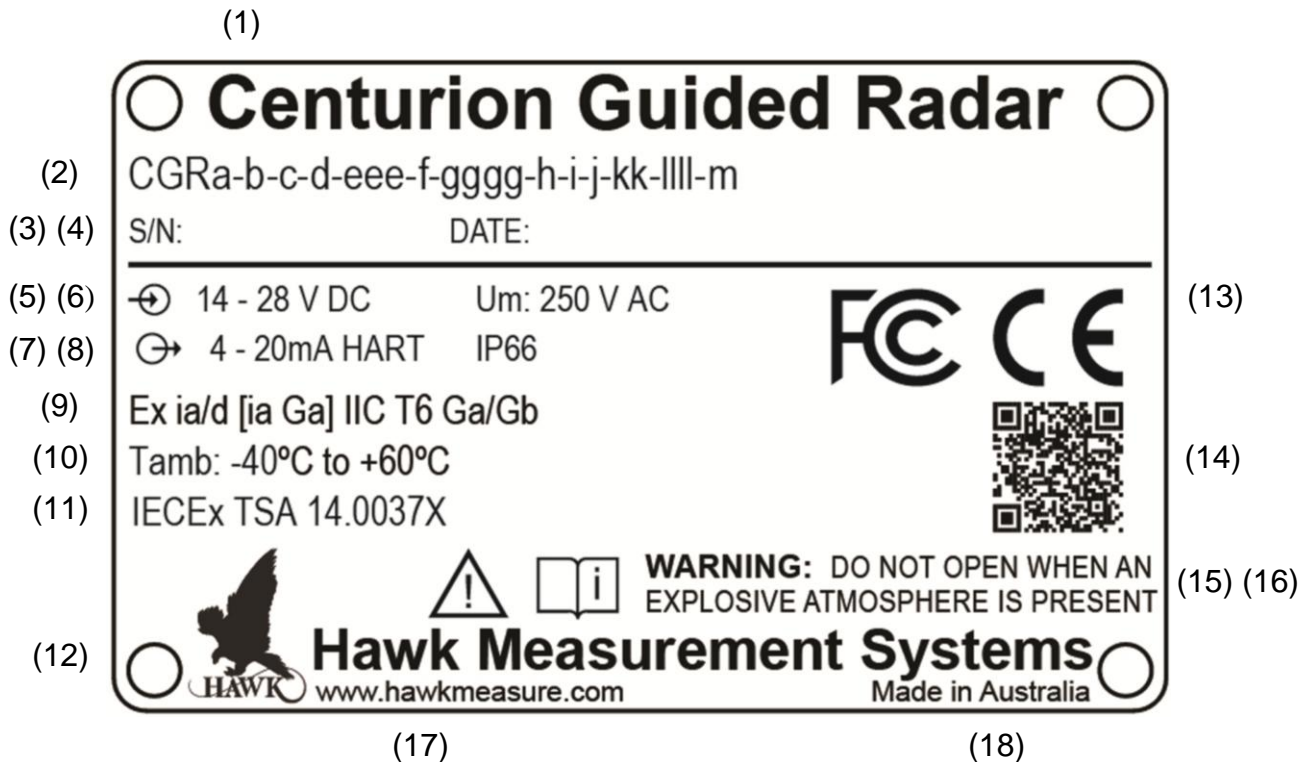

- (1) Product Name
- (2) Part Number
- (3) Serial Number
- (4) Manufacture Date
- (5) Input supply voltage range
- (6) Maximum value of  $U_m$  applied to non intrinsically safe circuits
- (7) Output current and communications protocol
- (8) Ingress Protection rating
- (9) Hazardous Locations Marking codes
- (10) Ambient Temperature Range
- (11) IECEx Certificate of Conformity number
- (12) Manufacturer Logo and Name
- (13) FCC and CE marking symbols
- (14) Quick Reference code
- (15) Warning symbol and reference to written instructions
- (16) Warning message
- (17) Manufacturer Web Address
- (18) Manufacturer country

## 4. Dual Compartment Enclosure

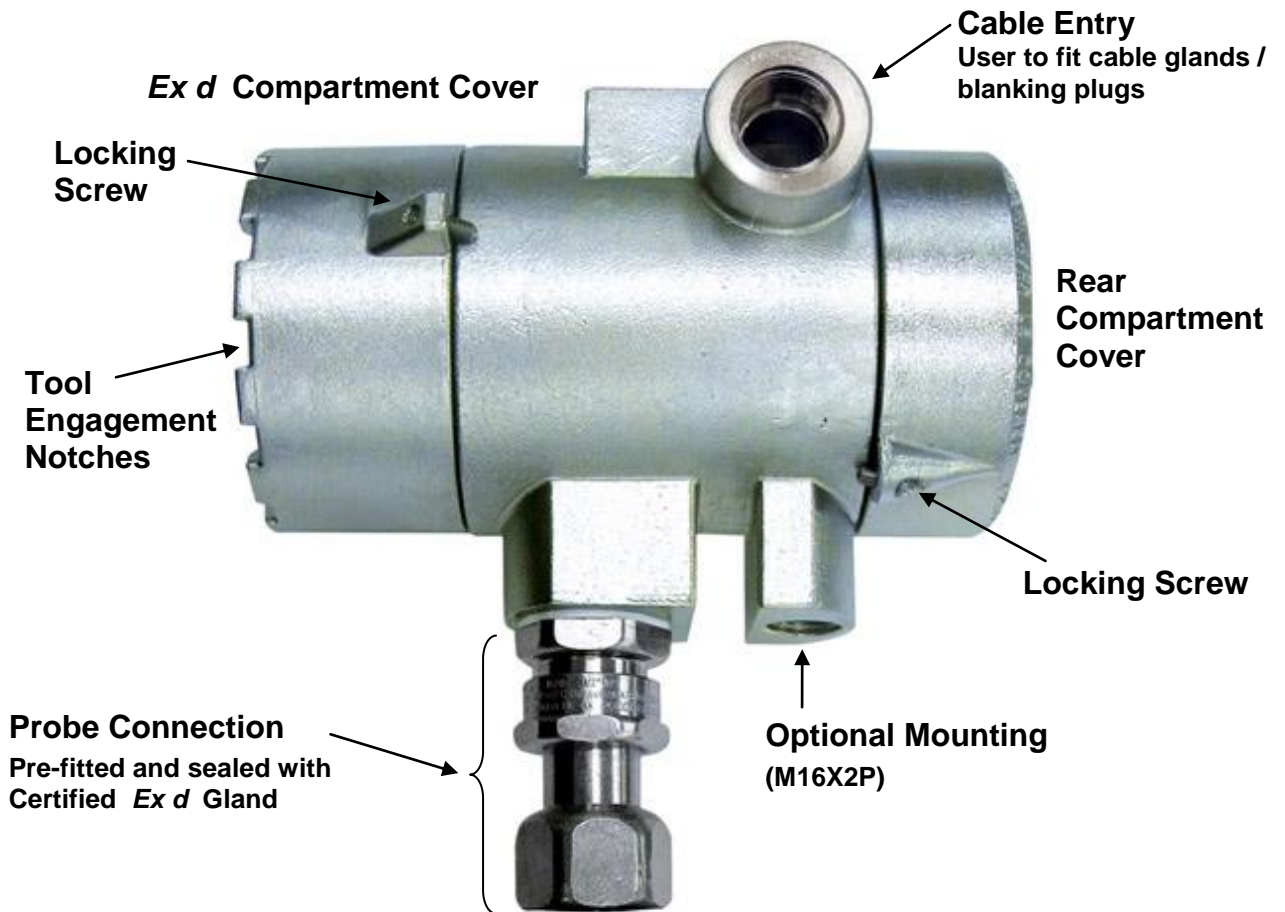

## 5. Putting Into Service

To put a HAWK CGR unit safely into service, the following steps must be taken:

- a) Follow the instructions in Typical Installations and Installation Guide.
- b) All CGR series models are fitted with an Ex d cable gland between enclosure port and the sensing probe. This gland must not be tampered with and it must remain tensioned as it was during manufacture. **Install the unit from the Process Fitting only.** (see also Pg.12)  
Do not rotate by grasping the enclosure.
- c) Cables coming into the CGR unit shall be sealed using certified Ex d cable glands and all unused cable entry points shall be sealed using certified Ex d blanking plugs. **These cable glands and blanking plugs should be certified to same or higher EPL and IP rating as the CGR Unit and fitted by the qualified technician.**
- d) Correct wiring.

Follow the instructions in the Wiring Diagram sections. Wiring should be in accordance with relevant installation standards for hazardous area equipment or other local codes of practice.

- e) Safe temperature

Temperature must not exceed the operating range of the CGR unit. In particular, Ex rated equipment must not exceed the temperature limits shown on the marking nameplate (see Pg.6).

Maximum device temperatures dependent on temperature classes are given in the table below:

Temperature Class	Sensing Probe Temperature	Enclosure Temperature
T6	-40°C to +85°C	-40°C to +76°C
T5	-40°C to +100°C	-40°C to +76°C
T4	-40°C to +135°C	-40°C to +76°C
T3	-40°C to +200°C	-40°C to +76°C
T2	-40°C to +300°C	-40°C to +76°C
T1	-40°C to +450°C	-40°C to +76°C

Temperatures above those specified in this table should not be exceeded.

- f) Safe Pressure.

Process pressure subjected to the sensing probe in EPL Ga and Gb hazardous areas must be between the limits of 80 to 110 kPa. (0.8 bar to 1.1 bar)

- g) Safe power supply.

Power supply values must be according to those stated in the Specifications.



h) Probe Tensile Force (Flexi cable models)

Probe Type	Tensile Force
Stainless steel rope, 4 mm @ 20°C	5 kN
Stainless steel rope, 6 mm @ 20°C	10 kN
Stainless steel rope, 8 mm @ 20°C	40 kN

i) Probe Lateral Force (Rigid and Coaxial models)

Probe Type	Lateral Force
Rod, 4 mm	1 Nm
Rod, 6 mm	3 Nm
Rod, 8 mm	8 Nm

j) Do not put into service where there is a possibility of contact with acetic acid.

## 6. Conditions of Safe Use

The instructions for safe use of the CGR unit are as follows:

- a) The CGR equipment must put into service safely. (see **Putting Into Service**, above).
- b) Warning: **Do not open the enclosure when an explosive atmosphere is present.**
- c) The User Manual must be read and understood by any person involved with this unit.
- d) Environment and installation conditions should be checked regularly.
- e) Process pressure at the sensing probe in EPL Ga and Gb areas must be between 80 to 110 kPa. (0.8 bar to 1.1 bar)
- f) When opening the cover of any CGR unit, prevent dust, liquids or chemical substances from getting inside the unit. Do not leave any cover open in rain or snow conditions.
- g) The LCD display on the CGR series transmitter is visible through the clear window.
- h) Before making any wiring or hardware configuration changes, it is important to disconnect power from the equipment.
- i) The enclosure has a non-conducting coating and may generate an ignition-capable level of electrostatic charge under certain extreme conditions. The user shall ensure that the equipment is not installed in a location where it may be subjected to external conditions (such as high-pressure steam) which might cause a build-up of electrostatic charges on non-conducting surfaces. Additionally, cleaning of the equipment should be done only with a damp cloth.
- j) When incorporated into an electrical system, the service temperature range the enclosure is exposed to shall not exceed -40°C to +76°C.
- k) Hawk CGR units must not be installed in areas with direct and continuous vibration.

## 7. Assembling and dismantling (Front & Rear covers only)

Only the front and rear covers of the Ex d enclosure are able to be removed in CGR series models, and only if an explosive atmosphere is not present.

*It is absolutely essential that this procedure is not done if an explosive atmosphere is present.*

The user interface controls and the rear terminal cover are able to be accessed by loosening a set screw then unscrewing the top cover with the aid of a suitable hand tool which does not cause any damage to the equipment.

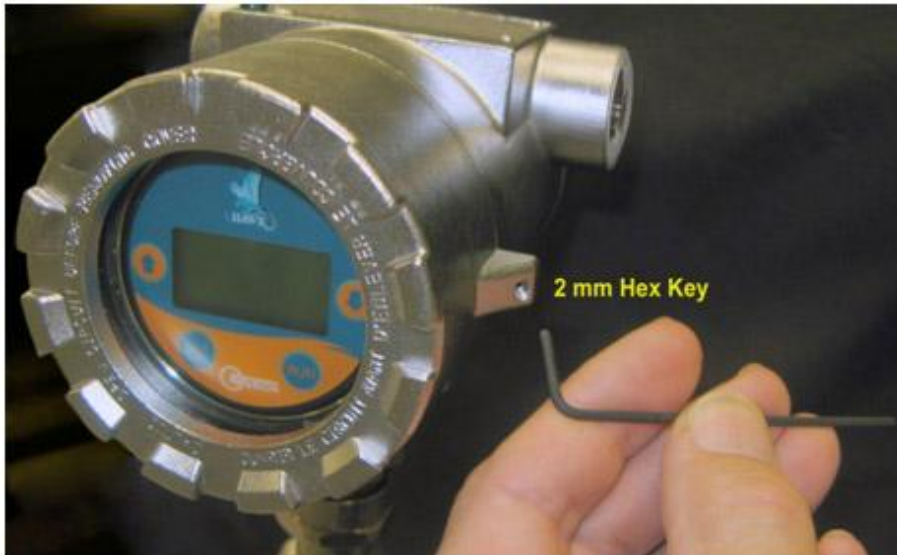

**WARNING !**  
**DO NOT OPEN**  
**WHEN AN**  
**EXPLOSIVE**  
**ATMOSPHERE**  
**IS PRESENT**



## 8. Installation and Wiring

Carefully follow Typical Installations, Installation Guide and Wiring Diagram section in the User Manual. Follow all points listed in Putting Into Service, above. Tighten at process fitting (Pg.12)

Wiring should be in accordance with relevant installation standards for hazardous area equipment (eg, IEC 60079-14) and any other local codes of practice.

## 9. Adjustment

### a) Software Adjustment:

For software adjustment of CGR unit parameter adjustment and data entry, refer to instructions in Entering Data, and all of the Setup sections.

If *GosHawk II* software is to be used for parameter adjustment and data entering from a lap-top computer, etc, the user must first read and fully understand the information in the *GosHawk II Manual* either supplied with the equipment or downloaded free from the HAWK web-site: <http://www.hawkmeasure.com>

Basic parameter adjustments to CGR units with HART communications option can be remotely adjusted using a standard HART calibrator.

*Note: Computing equipment and mobile phones should not be used in a hazardous area.*

### b) Hardware Adjustment:

The only hardware adjustment allowed is shortening of the Hawk supplied Flexible and Rigid probe length to suit the measuring span on site.

*Refer to user manual for more information*

## 10. Enclosure (LCD) Orientation

*The Ex d gland which couples the sensing probe to the flameproof enclosure provides a critical sealing function for the enclosure. Internal wires are passed through this gland and the high integrity seal. This gland incorporates a Union Joint which is designed to rotate.*

*However this rotation is limited to one-time adjustment of Display orientation after installation on site, as shown below:*

ONLY one 36mm spanner applied to the Hex of Union Joint to rotate enclosure to desired orientation as allowed. **DO NOT** hold the enclosure during this procedure.

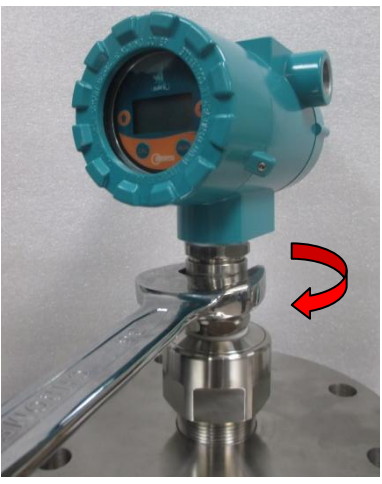
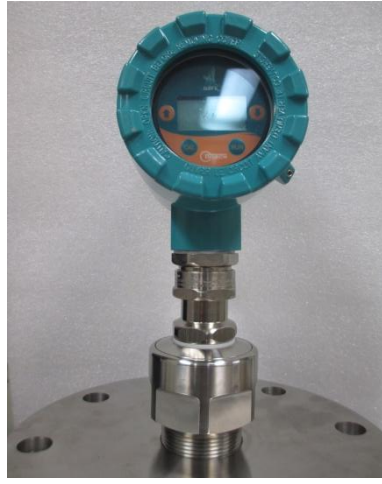
		
<p>As Installed, but LCD display not visible.</p>	<p>Rotation at Union Joint <b>Max 360° allowable one-time rotation in either direction.</b></p>	<p>Desired Orientation.</p>

### Note:

- **Rotation beyond these strict limits can damage the internal cables**
- **Ensure Enclosure follows the spanner rotation and assembly integrity is not compromised**

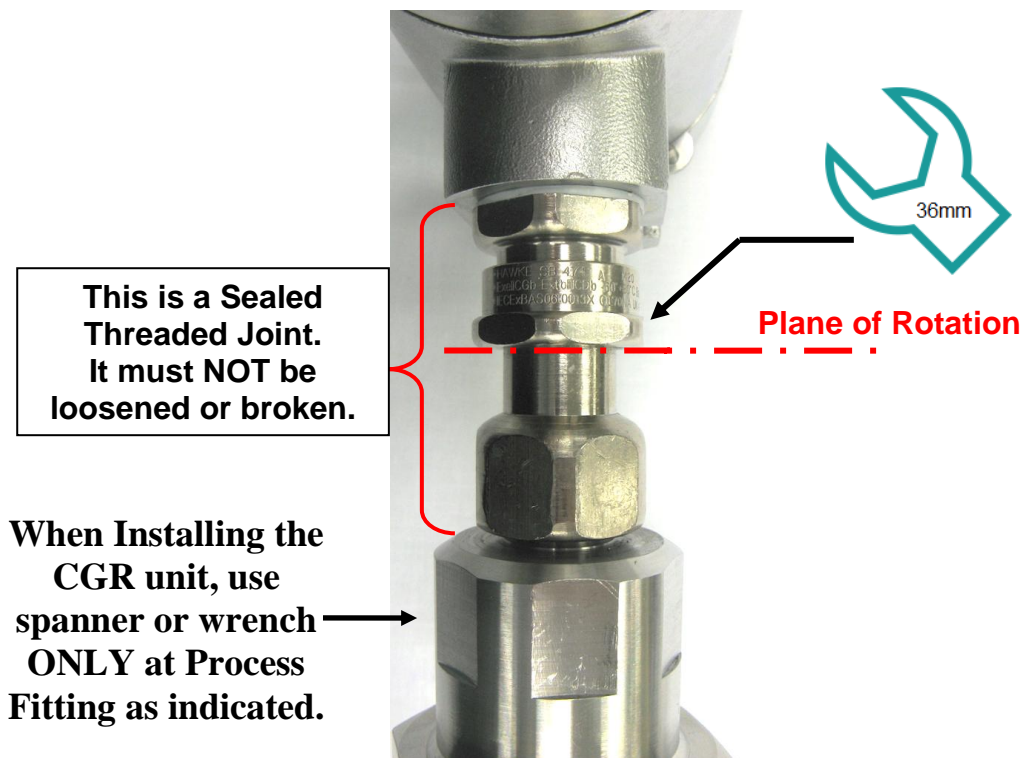

## 11. Application Conditions

### a) Voltage Supply:

Must be according to the voltage supplies given in Specifications

$U = 14 \dots 28 \text{ V DC}$  Peak voltage that can be applied to the equipment without invalidating the type of protection.

$U_m = 250 \text{ V AC}$  Maximum voltage that can be applied to the non-intrinsically safe connection of associated equipment without invalidating the type of protection.

### b) Temperature:

Temperature must not exceed the operating temperature range stated in Putting Into Service, above.

### c) Cable Connection:

Cables and wiring must be installed according to the appropriate standards.

Cable connection compartment must be sealed using appropriate glands and blanking plugs. (Refer to Section 5.c of Putting Into Service)

If extending the cable, it must be protected in a junction box and terminated in an enclosure suitable for the environment.

Refer to Wiring Diagrams.

### d) Earthing:

HAWK CGR equipment should be earthed via a resistance of less than 1 MegOhm to the Earthing Screw to reduce the possibility of electrostatic discharge.

### e) Electrostatic Discharge:

**Warning: Avoid Electrostatic Discharge**

Do not rub the non-metallic surface of this equipment with a dry cloth.

Do not install this equipment in areas where nonconductive materials could flow onto the enclosure surface.

### f) Industrial Conditions:

This equipment is designed for use in normal industrial conditions relating to humidity, vibration, etc. If the user intends to operate the equipment in more severe environmental conditions, the manufacturer or local distributor should be consulted for advice.

## 12. List of IECEx certified equipment types:

2 wire Centurion Guided Radar – CGR2 series  
4 wire Centurion Guided Radar – CGR4 series

Probe, Flange and Accessory selection in any combination

## 13. Wiring configuration drawings:

Refer to Wiring Diagrams

Note: All equipment in Hazardous Areas must have appropriate certification.

## 14. Approval Standards:

IEC 60079-0:2011, Sixth edition	Explosive Atmospheres – Equipment - General Requirements.
IEC 60079-1:2007, Sixth edition	Equipment protection by flameproof enclosures ‘d’.
IEC 60079-11:2011, Sixth edition	Equipment protection by intrinsic safety ‘i’.
IEC 60079-26:2014, Ed. 3.0	Explosive Atmospheres – Equipment with EPL Ga.
IEC 60079-31:2013, Ed. 2.0	Equipment dust ignition protection by enclosure "t"

These standards specify test requirements at standard temperature, pressure and oxygen content. Additional consideration and/or testing may be required for equipment operating outside these limits.

## 15. IECEx Certificate of Conformity:

IECEx Certificate of Conformity IECEx TSA 14.0037X can be accessed directly on line using the following hyperlink ...

<http://iecex.iec.ch/iecex/iecexweb.nsf/certificatesAjax/IECEx TSA 14.0037X issue No. 1?opendocument>

or go to <http://www.iecex.com/>

select ‘View Certificates & Licenses’  
then click the ‘Certified Equipment’ box  
then enter IECEx TSA 14.0037X  
and click the ‘View certificate’ box to begin the search.

## 16. Manufacturer Contact Information

### **Hawk Measurement Systems**

#### **Head Office**

15-17 Maurice Court, Nunawading, Melbourne VIC 3131, Australia

PO Box 3230, Nunawading, Melbourne VIC 3131, Australia

Ph: +61 (0)3 9873 4750

Fax: + 61 (0)3 9873 4538

Email: [info@hawk.com.au](mailto:info@hawk.com.au)

Support: [techsupport@hawk.com.au](mailto:techsupport@hawk.com.au)

Web: <http://www.hawkmeasure.com>

### **Hawk Measurement**

#### **Corporate and Sales Office**

96 Glenn Street

Lawrence, MA 01843, USA

Ph: +1 978 304 3000 / +1 888 429 5538

Fax: +1 978 304 1462

Email: [info@hawkmeasure.com](mailto:info@hawkmeasure.com)

Web: <http://www.hawkmeasure.com>

Technical data is subject to change without notice.  
Images shown may differ from equipment supplied.

